

Hybrid Inverter

Quick Installation Instruction



Notification:
All the fasteners must be fastened firmly as per required here, or the faults caused by water ingress under this situation will not be warranted.

A Clearance

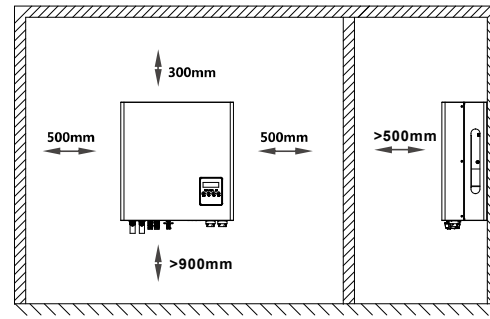

B Drill Holes

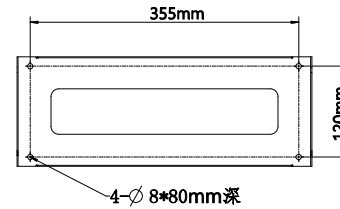

C Installation

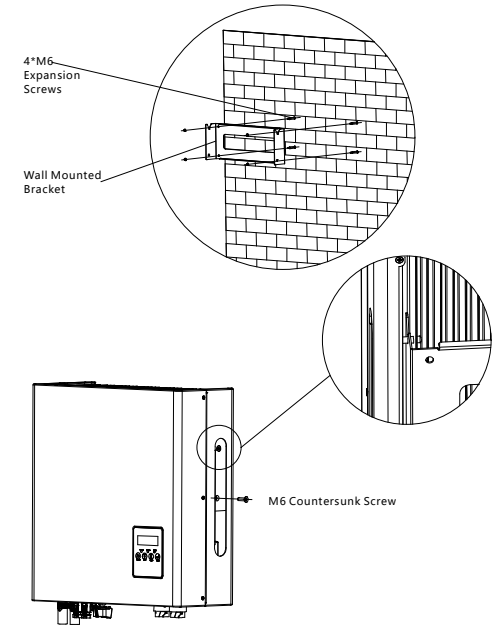

D AC/EPS Connection

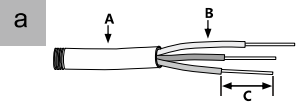

A. Diameter	10~12 mm
B. Cross Section	3~4 mm ²
C. Strip Length	~ 10 mm

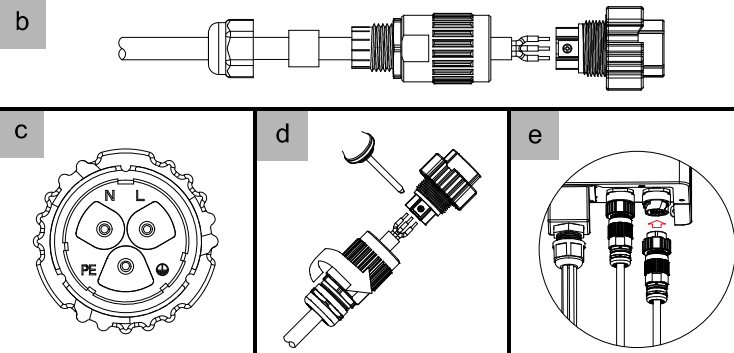

F Battery Connection

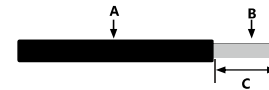

A. Diameter	10~12 mm
B. Cross Section	20~25 mm ²
C. Strip Length	~ 10 mm

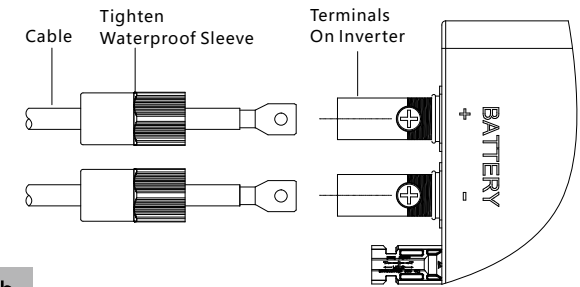

E PV Connection

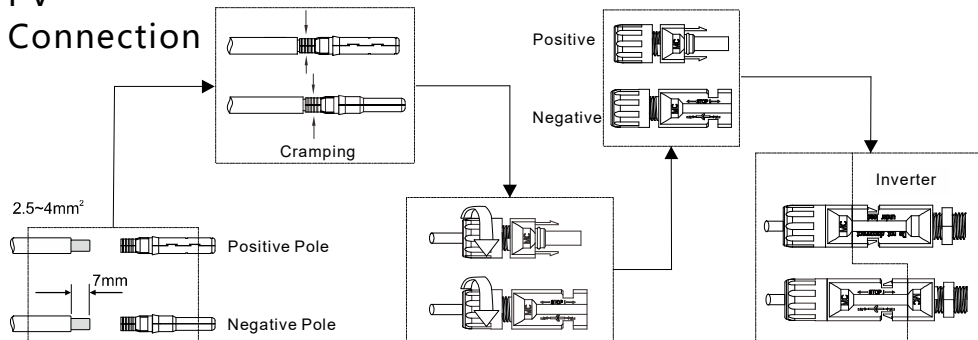

a

b

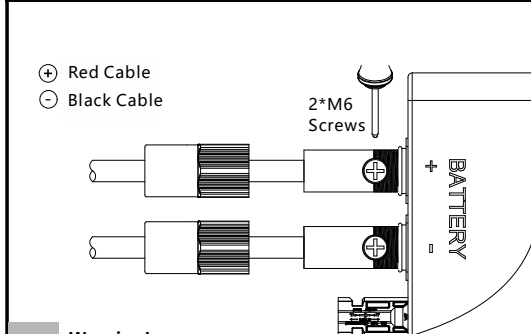

Warning!
Polarity reverse will damage the inverter!

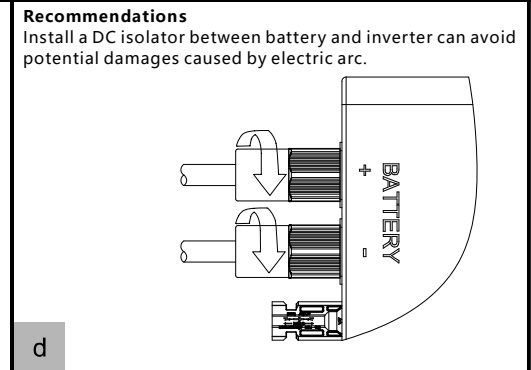

Recommendations
Install a DC isolator between battery and inverter can avoid potential damages caused by electric arc.

d

G Definition of Communication Cables

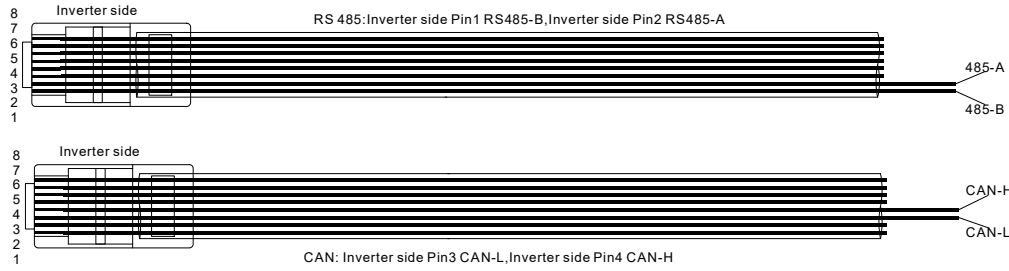

a Battery Communication Cables

b Meter Communication Cables

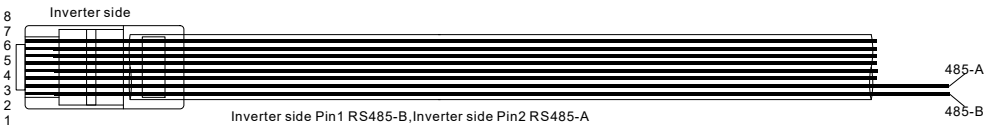

H Connection of Communication Cables

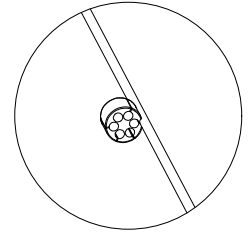
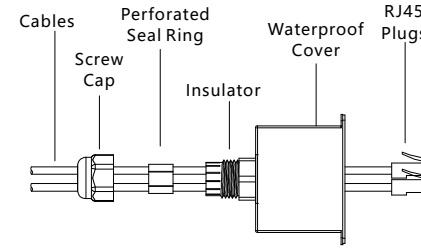

a Press the communication cables in the seal ring via the side incisions.

If the battery is communicated via CAN, turn below switches on as showed.

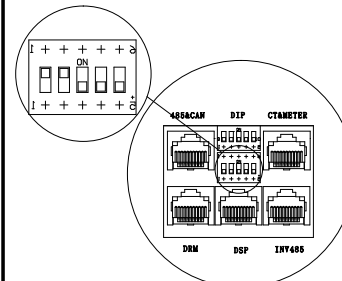

b Insert RJ45 plugs into corresponding ports.

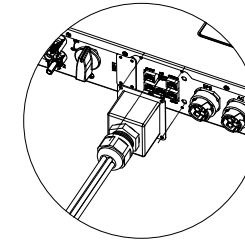

c Install the waterproof cover firmly using 4*M3 screws.

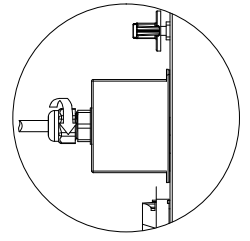

d Fasten the screw cap by clockwise tightening.

I Wi-Fi Module Installation

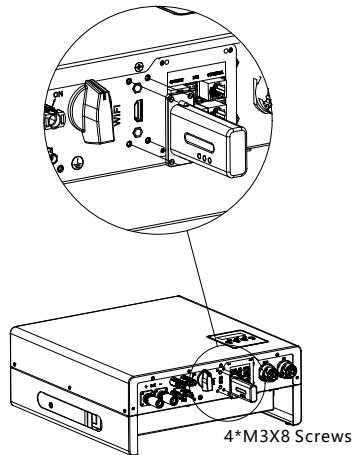

J Wi-Fi Communication Connection

a Connect AC connection and turn on AC breaker, wait till the LED indicators on Wi-Fi module flashing.

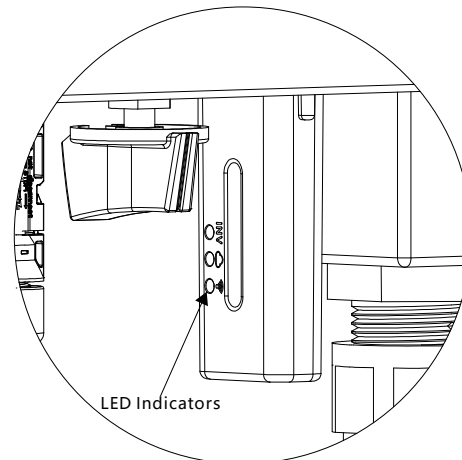

b Enter into Wi-Fi SSID and password setting interface by selecting "WIFI MODULE CONNECT" option at login interface of the APP, and operate along the guidance.

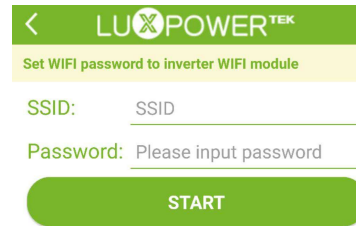

Please connect your mobile to the same router which your wifi module need to connect, then input password and click start.

Configure inverter WIFI module

CONFIG WIFI MODULE FROM WEB

Please connect your mobile phone to MCHIP_XXXXXX wifi networking first when wifi LED on wifi module is solid on, and then click CONFIG WIFI MODULE FROM WEB to config wifi module.

K Install Protective Shell

